

alsol.fr

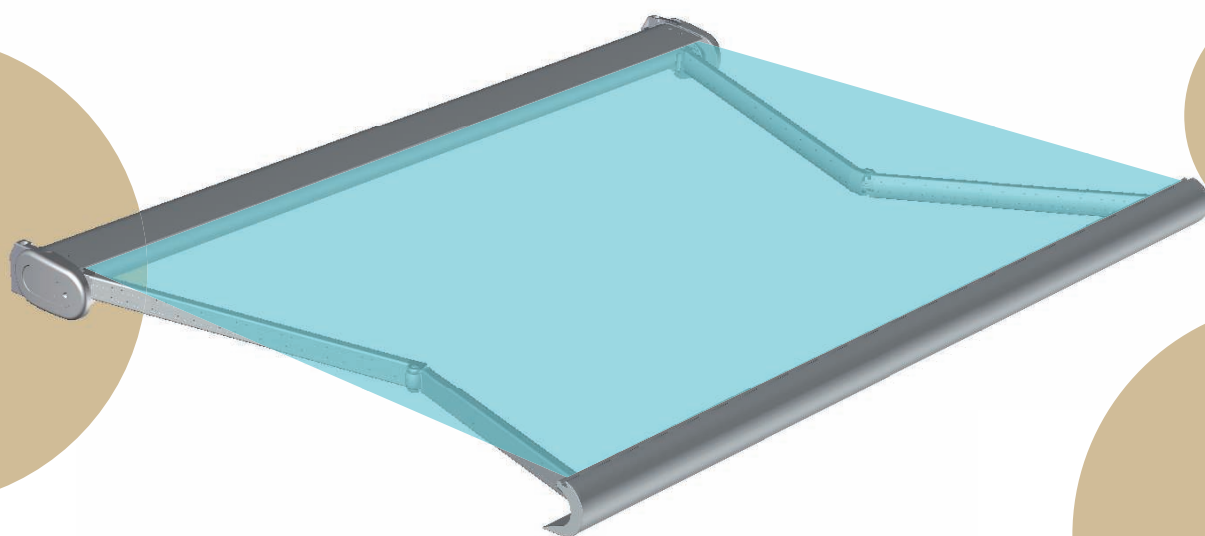

NOTICE
de pose



COFFRE
ORCHIDEE
Pose façade

Installation du coffre



2 personnes
pour le montage

Outils



1 Réception du coffre et accessoires.



IMPERATIF

Ne jamais ouvrir le store avant fixation complète.
Votre sécurité en dépend.

Avant la pose, vérifier la planéité du mur. Dans le cas d'un mur creux ou bombé effectuer un calage des supports afin de les aligner correctement



2 Fixation support de store.

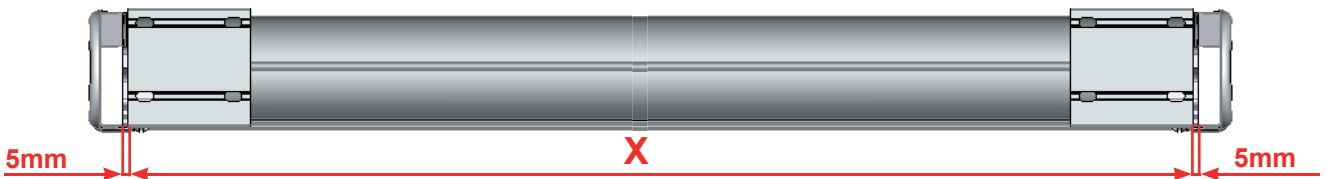

2-1

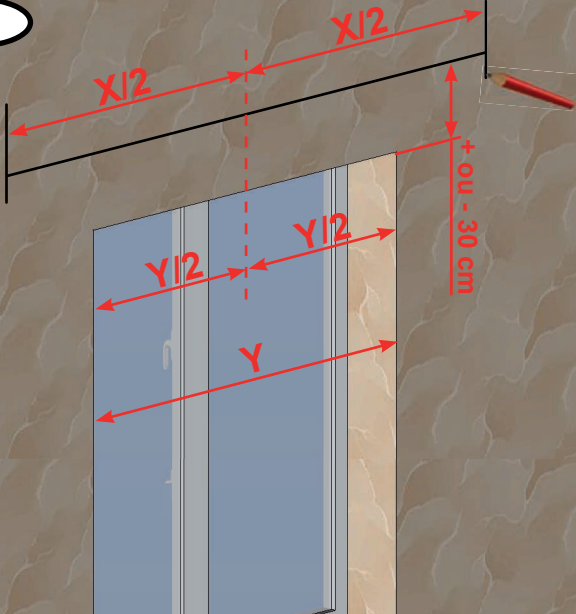

2-2

S'adapter à la nature du mur.

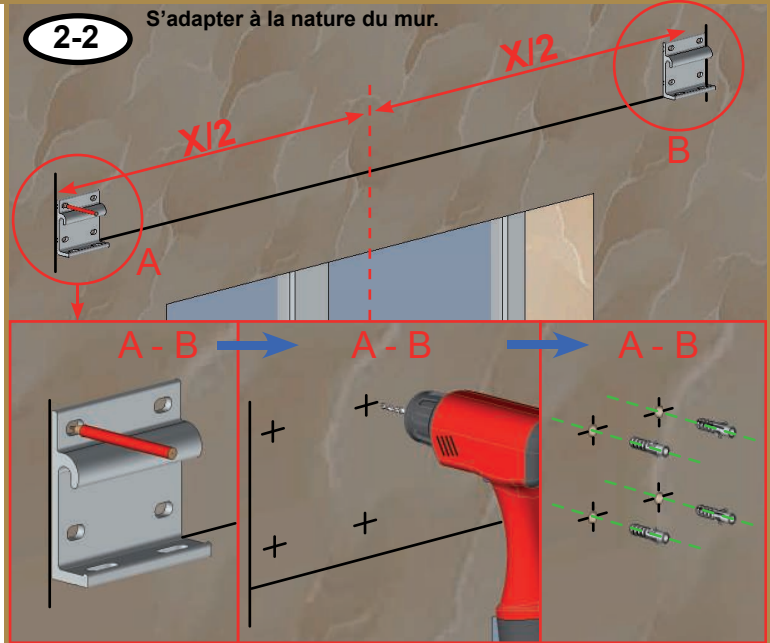

2-3

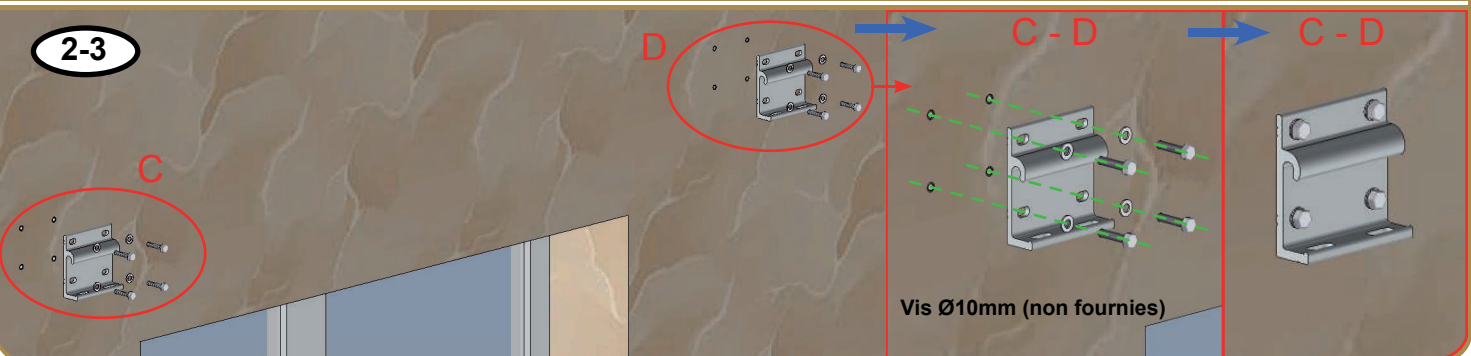

3 Fixation store.

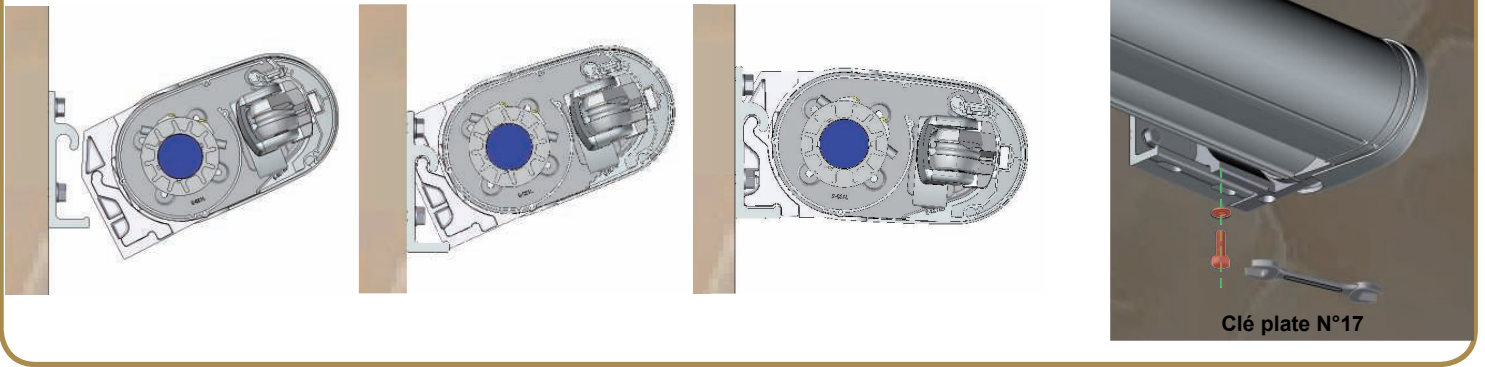

4 Réglage inclinaison (store ouvert).

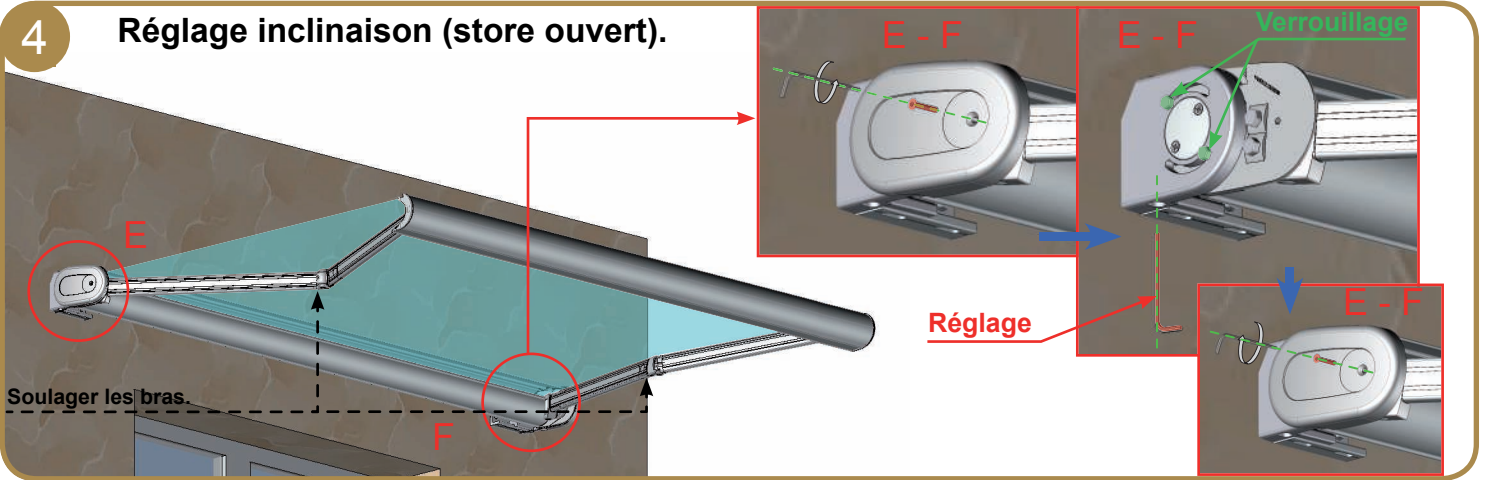

5 Problème de fermeture sur un côté.

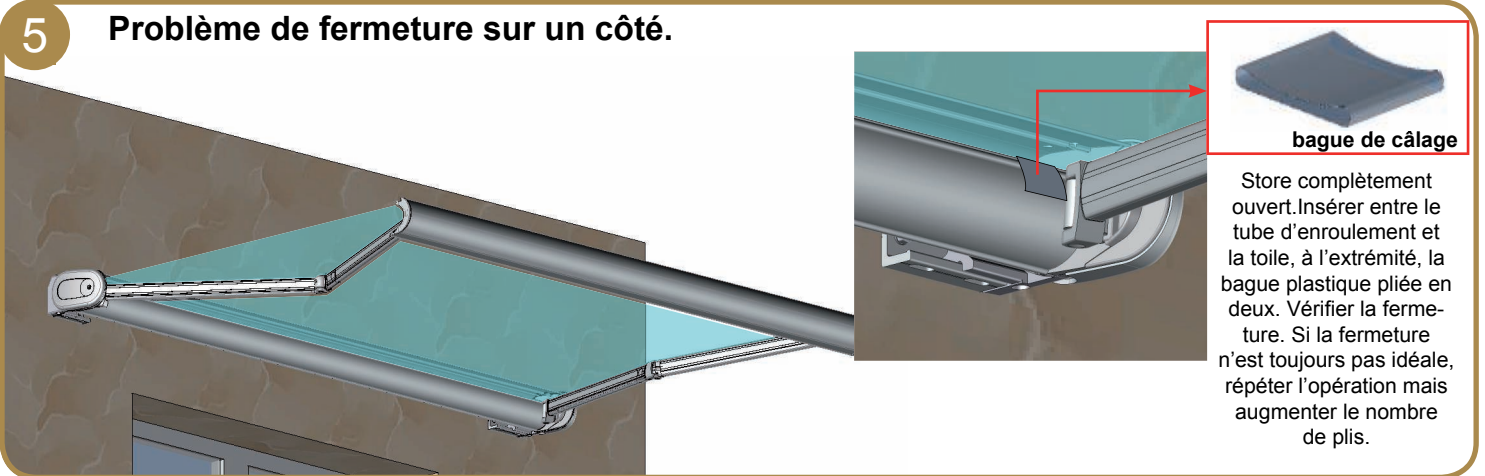

6 Réglage fin de course.

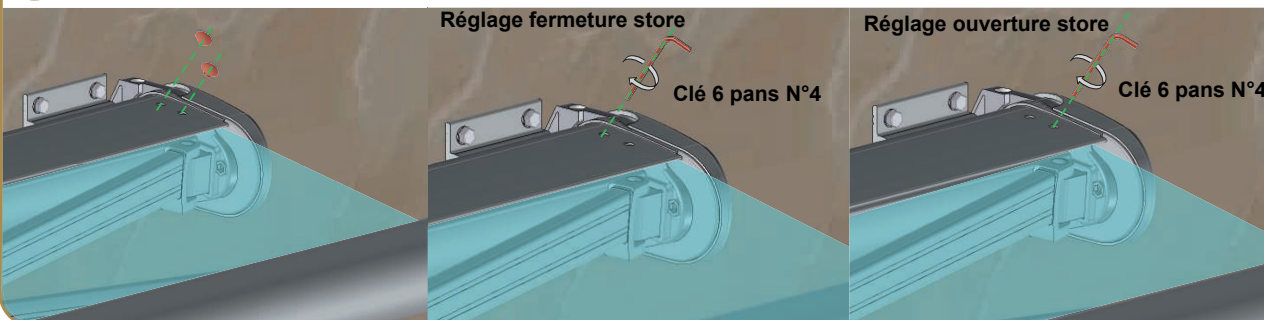

Installation terminée.





alsol.fr

www.alsol.fr